



INSTUCTION MANUAL



INDEX

INTRODUCTION	page 4
USE	page 4
1. INSTRUCTIONS OF USE	page 5
1.1 Packaging and Transport	page 5
1.2 Preliminary Operations for correct Commissioning	page 5
1.3 Adjustments for the first Commissioning and/or subsequent adjustments.....	page 7
1.4 How to use it	page 14
1.5 Recommendations for Use	page 18
2. GENERAL WARNINGS	page 18
2.1 Warnings for the Professional User	page 18
2.2 Warnings for the End User	page 18
3. NEGATIVE ADVERSE EFFECTS	page 20
4. RESTRICTIONS OF USE	page 20
5. STANDARD MANTEINANCE	page 20
6. ADAPTATIONS WITH STRUCTURAL CHANGES AND/OR SPECIAL MAINTENANCE	page 21
7. PERFORMANCE AND DURABILITY	page 21
8. WARRANTY	page 21
9. POST-MARKET SURVEILLANCE AND POSSIBLE INCIDENTS	page 22
10. DISPOSAL/RECYCLING	page 22
11. LABELING.....	page 23
ANNEXES:	
-> Annex A: Technical features	page 24
-> Annex 1: Warranty replacement of components/ Adaptations with structural changes and/or Special Maintenance	
-> Annex 2: Report of after-sales incidents	

NOTE The Illustrations in the following Instruction Manual may differ from reality; however, the methods of use and operation remain valid at all times. All technical data in this manual are approximate and do not constitute specifications.

INTRODUCTION

Dear User, thank you for choosing highly performing Pro Medicare medical device.

LEO is the Frame for Positioning System, it is the combination of technology and experience in the development of Positioning Systems for users with limited ability. Thanks to its modularity and different possibilities of adjustment, LEO allows effective adaptation to changes of the user's needs and requirements, providing the best comfort with maximum functionality.

As manufacturer, Pro Medicare declares that the medical device complies with Regulation (EU) 2017/745.

Pro Medicare's Quality Management System is certified according to UNI EN ISO 9001 and UNI EN ISO 13485 standards.

This manual, drawn up on the basis of the requirements of Regulation (EU) 2017/745 on medical devices, is an indispensable tool for learning how to use the Device safely.

This manual contains all instructions for a correct and safe use of the frame combined with the positioning system.

To this end, it is important to read the information about how to use it carefully, with the express invitation to follow the prescribed indications.

As a manufacturer, Pro Medicare refers to the Professional User as the suitably qualified person (authorised dealer, orthopaedic technician, occupational therapist, healthcare professional, etc.), and to the End User as the person who is intended to use the Device (caregivers, family members, etc.).



The first commissioning, subsequent adjustments and Special Maintenance must exclusively be performed by the Professional User.

The Technical features of the device are reported in the Annex A "Technical Features".

After consulting this manual, for further information, please contact the Technical Sales Department at the following number:

+39 0831 777840

Monday to Friday from 9 a.m. to 1 p.m. and from 2.30 p.m. to 6.30 p.m.

In case of emergencies outside the working hours, please send a fax to the following number:

+39 0831 730739

Or send an email to: sales@promedicare.it

We will call you back as soon as possible.

In order to ensure appropriate After-Sale Monitoring of Devices placed on the market and put into service, or in the event of an incident during the use, please refer to the instructions stated in the relevant chapter.

USE

The LEO Frame for Positioning System is made of oxidized aluminium alloy to ensure lightness and long-lasting durability during the use.

It has been designed and manufactured in compliance with the safety standards of Regulation (EU) 2017/745.

LEO, due to its modularity, is able to follow the evolutions of the pathological scheme of the users as well as the growth and the postural changes. The device, combined with the relevant positioning system, is intended for a personal use and has to be used with the assistance of a caregiver both indoor and outdoor.

The Professional User is the responsible for the safety performance of the LEO Frame for Positioning System and the Positioning System combination specially manufactured for the specific user and in compliance with the Standards.

The first commissioning, subsequent adjustments and Special Maintenance must exclusively be performed by the Professional User. If a custom-made Positioning solution is fitted and adjusted as prescribed, it may not be used for other users.

Any removal and/or changes of the standard configuration, and configuration for the specific user based on the prescription, must exclusively be performed by the Professional User and make it a custom-made Device.

The CE Declaration of Conformity refers exclusively to the Medical Device prepared and provided by the manufacturer, "as-is", when the Device is unchanged with respect to the standard configuration. The Professional User has the responsibility to guarantee the effectiveness and efficiency of the Device specially manufactured for the specific user.

Pro Medicare is constantly dedicated to innovate its own Devices; This can entail changes in form or technique on the devices and/or related accessories. Therefore, hypothetical complaints on values, images and schemes defined in the this manual, will not be accepted. Furthermore, for the complete list of the optional parts and/or accessories, please refer to the latest order form in force.

1. INSTRUCTIONS OF USE

1.1 Packaging and Transport

The original packaging contains the following components:

- frame for Positioning System with backrest canes folded down, posterior wheels and footrest detached
- any Accessories as per order form
- labeling and Instruction Manual.

Upon delivery, please check for the integrity of the package and immediately note any damages or anomalies on the shipping document. Then open up the packaging and check that the various parts do not show dents, drippings, deformations or tears. Otherwise note the anomalies found on the shipping document.

After performing these checks and if the product has not to be put into immediate use, we recommend to repack and store it in a dry place.

The above operation will be carried out by the Professional User who has to perform the assembling procedures of the Frame for Positioning System with the Positioning System.

1.2 Preliminary Operations for correct Commissioning

A positioning system produced by different manufacturing company, when installed on a LEO frame, should have the seat and backrest with a proper mounting system for a good fit on the tubes of the frame (25mm).

The professional user and the end user should check that the frame/posture connection system is safely manufactured.

The frame is delivered with all movable components disassembled; it is necessary to put it in service.



These operations must exclusively be performed by the Professional User, who is responsible for the safety performance of the combination and/or configuration.

1.2.1 Operations for the "commissioning of the Frame"

1) Assembling the posterior wheels

To assemble the posterior wheels, insert the quick-release axle in the special bush fixed in the mounting plate (pic. 1), by pressing and then releasing the button.

Verify the correct inserting of the wheels by checking:

- the release of the button of the quick-release axle;
- the impossibility of movement of the wheel.

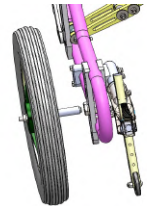

pic. 1: Assembling the posterior wheels

2) Unfolding backrest tubes

- Pull the backrest tube by the push handles and bring it in upright position (pic. 2)
- Insert the posterior eyelet of the gas spring into the appropriate seat of the clamp
- Insert the quick-release pin in the relevant hole, by pressing and then releasing the button.



Check the correct positioning of the backrest tube by checking:

- the backrest tube do not move
- the quick release can't be detached.

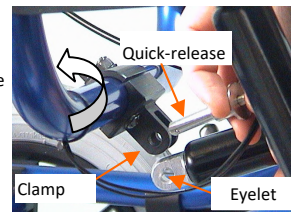

pic. 2: Backrest tube

3) Inserting the legrest tubes

◆ Detachable version

- insert the insert slotted edge of the legrest tube into the seat tube (pic. 3.1) until click is heard to indicate insert engagement into its housing.
- verify both legrest tubes are locked in position: they should not move if pulled.

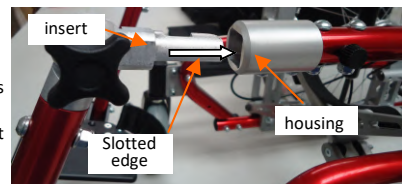

pic. 3.1: Inserting the legrest tube (detachable version)

◆ **Swing-away and detachable version**

- insert the legrest tube perpendicularly to the seat tube (Pic. 3.2).
- insert the guide in the appropriate receptacle in the superior part of the tube.
- rotate the legrest tube inward until the collar locks with the receptacle pin indicating it has been gripped.
- verify the correct positioning by checking the impossibility of rotation of the legrest tube.

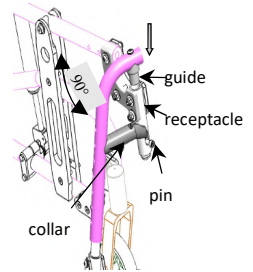

pic. 3.2: Inserting the legrest tube (swing-away version)

Vertical elevating telescopic knee angle (pic. 3.3):

- place the legrest tube insert in the corresponding seat and tighten with the clamping lever
- verify the proper insertion by checking the impossibility of rotation and detachment of the legrest tube.

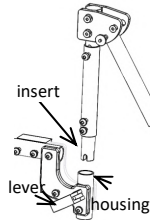

pic. 3.3: Inserting the legrest tube (vertical knee angle)

4) Checking the tyre pressure (where provided)

Ensure that the pressure is always as indicated on the tyre because the brake efficiency depends on it.

5) Anti-tip System checking

* **Standard and fixed version:**

This component reduces the risk of the structure tipping over under normal conditions of use.

The anti-tip system works properly (pic. 4.1) if they are between 25mm and 40mm from the floor; if they are positioned too high they do not reduce the risk of tipping, if they are positioned too low they can hit obstacles. To activate the anti-tip system (pic. 4.3) pull the ring outwards and slide the anti-tip system tube:

- pic. 4.2 shows the anti-tip system is positioned too high and it is not working properly
- pic. 4.1 shows the anti-tip system is positioned in a good distance from the floor and it is working properly

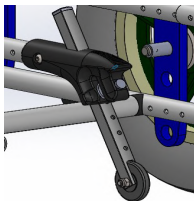

pic. 4.1

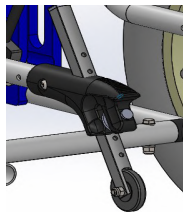

pic. 4.2

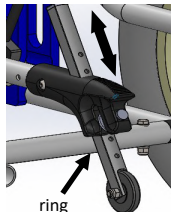

pic. 4.3

* **Detachable version** (pic. 4.4) when provided:

This system can have the option to completely remove the anti-tip system from the frame only by pushing the pin showed in pic. 4.4. For inserting, squeeze the button and insert the tube by sliding it until the button stops in its housing.

Verify the correct operation by ensuring the impossibility of movement or detachment of the device from the frame.

See "Standard and fixed version" section to read instructions about the functioning

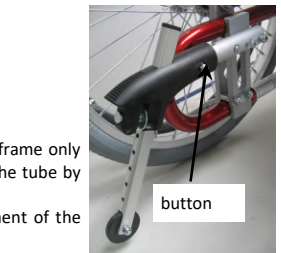

pic. 4.4: Detachable anti tip system



It is absolutely forbidden using the anti-tip system, both in the standard and detachable versions, as pedal for overcoming barriers.

6) Checking the Parking Brake (pic. 5)

To activate the parking brake, push the lever forward until a “click” is audible and the brake is pressing against the tyre. Check that the wheel doesn’t move. Please release the lever to unlock the brake. To ensure that the wheel stops correctly, check that the distance between the brake and the wheel tyre is 6 mm. If not, please adjust as follows:

- Unscrew the 2 brake clamp fixing screws
- adjust the distance between the brake and the wheel tyre (estimated value: 6 mm)
- Screw the 2 fixing screws
- Check the wheels stop correctly.

If the wheel is equipped with a drum brake, it is necessary to check for the proper function by activating the lever located on the backrest tube. Once the lever is activated, the wheels are locked with no possibility of movement. If the lever is not pressed, the wheels will be able to move freely. These brakes can be used to brake the system while is using. The braking force of the drum brake can be adjusted using the adjusting screw on the brake cable near the brake hub.

The braking force can be increased by slightly unscrewing the adjustment screw. Loosen the nut and unscrew the screw until a friction noise is heard in the wheel rotation. Retighten the screw until the friction disappears. Tighten the nut to secure the adjusting screw.

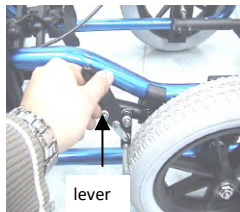

pic. 5: Activating the brake lever



Take care to adjust the drum brakes on both sides of the frame in the same way.

7) Checking the Gas Springs

Verify that the gas springs do not leak oil. Check the functionality by means the lever located on the right tube handle which operates the gas spring of the tilting mechanism and the lever located on the left tube handle which operates the gas spring of the reclining mechanism.



After all these operations please ensure that the frame moves easily and all components work properly. If you hear noise, vibrations or if there are any changes to the normal conditions of use, please contact the Professional User; He will check the safety conditions, the suitability for use and the effectiveness of the Device.

8) Checking the Pedal (where provided) (pic. 6)

The pedal must only be used to overcome barriers (step); to use it, please perform as follows:

- push the anti-tipping system upwards.
- lower the pedal to a horizontal position
- push on the pedal with your foot, also using the push handles to overcome the barrier (do this very slowly, gradually and with care)
- place the pedal back in an upright position to avoid accidental impacts when transporting the user.



After overcoming the barrier, please pay attention to handling. If you hear noise, vibrations or if there are any changes to the normal conditions of use, please contact the Professional User; He will check the safety conditions, the suitability for use and the effectiveness of the Device.



pic. 6: Pedal

1.3 Adjustments for the first Commissioning and/or subsequent adjustments

The Frame combined with the Positioning System is now ready to be used. Adjustments for the first Commissioning and subsequent adjustments to the changing needs of the end user are possible thanks to multiple adjustment possibilities of the frame. All possible adjustments are described in this chapter.



These operations must exclusively be performed by the Professional User, who is responsible for the safety performance of the combination and/or configuration.

1) Tilting seat (tilt in space)

The adjustment of the tilt in space is performed by two gas spring by operating the lever on the right hand push handle. In this way the tilting of the seat is adjustable in a continuous way.

When the lever is released, the gas springs will block the seat at the reached position.

If this operation is performed with the user seated in the system, it is necessary to hold the push handles with both hands.

Then proceed by activating the gas spring and the tilt mechanism.

Please, perform this operation very slowly gradually and with care.



While performing this operation, always ensure that the anti-tip system is fitted and correctly positioned and the user is well seated on the seat by wearing a pelvic belt.

Also ensure that the forearms are positioned on their upper limb supports to reduce the risk of trapping.

2) Reclining the backrest

The reclining is performed using the gas spring by operating the lever on the left hand push handle.

The reclining is adjustable in a continuous way by operating the lever.

When the lever is released, the gas springs will block the backrest at the reached position.

If this operation is performed with the user seated in the system, it is necessary to hold the push handles with both hands. Then proceed by activating the gas spring and the reclining mechanism. Please, perform this operation very slowly gradually and with care.

3) Adjusting the footplates

The footplates can be adjusted in height, depth and angle.

• Height Adjustment of the footplates:

* Detachable version (pic. 7.1):

- unscrew and remove the exagonal head fixing screw
- move the fixing clamp of the footplate along the tube until the desired position is achieved
- reinsert the screw in the appropriate hole and screw without thightening the self-locking nut
- the regular thightening is achieved when the screw exits from the thread of the plastic ring of the self-locking nut.

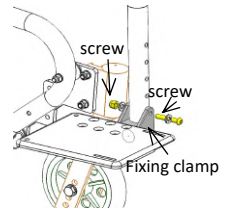

pic. 7.1: Height adjustment

* 90° and 75° version (pic. 7.2)

- unscrew and loosen the fixing screw of the telescopic tube
- move the insert along the legrest tube until the desired position is achieved
- reinsert the screw in the appropriate hole and thighten

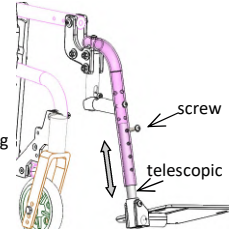

pic. 7.2: Height adjustment

* Vertical elevating and telescopic knee angle, can be adjusted by operating on the locking lever located on the tube:

- open the locking lever
- Move the tube until the desired position is achieved
- Close the lever

• Depth Adjustment of the footplates (pic. 7.3):

- unscrew and remove the 2 countersunk head fixing screws
- move the footplate back and forth until the desired position is achieved
- reinsert and thighten the screws.

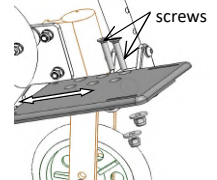

pic. 7.3: Depth adjustment

• Angle Adjustment of the footplates (pic. 7.4):

- unscrew and loosen the 2 countersunk head fixing screws
- rotate the footplate clockwise or counterclockwise until the desired position is achieved;
- reinsert the fixing screws and thighten securely.

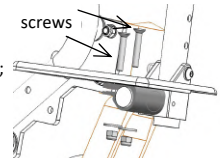

pic. 7.4: Angle adjustment

4) Knee Angle Adjustment (where provided)

• Elevating with teathed mechanism version (pic. 8.1)

- unscrew and loosen the fixing knob
- rotate the legrest tube until the desired position is achieved
- tighten the fixing knob gradually so as the teathed mechanism engages and blocks the position of the legrest tube.

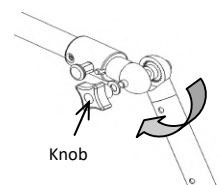

pic. 8.1: Elevating with teathed mechanism knee angle adjustment

- **Elevating with spring pin version (pic. 8.2)**
 - Push the lock pin
 - Rotate the legrest tube until the desired position is achieved
 - Release the lock pin and fix the inclination of the legrest tube

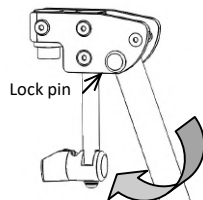

pic. 8.2: Elevating with spring pin knee angle adjustment

- **Vertical elevating and telescopic version (pic. 8.3)**
 - * **Angle adjustment:**
 - Push the lock pin
 - Rotate the legrest tube until the desired position is achieved
 - Release the lock pin and fix the inclination of the legrest tube
 - * **Rotation Centre Adjustment:**
 - Unscrew the fixing screw.
 - Slide vertically the telescopic tube until the desired position is achieved
 - Engage the relevant hole
 - Tighten the fixing screws at a torque level of 13.5Nm

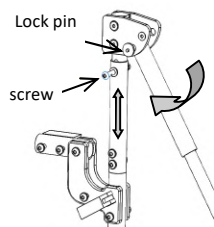

pic. 8.3: Vertical elevating and telescopic knee angle adjustment

5) Displacement of the plates

The frame is delivered in its standard features. Depending upon the users needs, it is possible the continuous horizontal displacement of seat with respect to the frame and the continuous displacement of the posterior wheels plates. These adjustments are analysed in detail below:

- Displacement of the seat -

The displacement of the seat with respect to the frame can be done as follows (pic. 9):

- unscrew and loosen the countersunk screws fixing both plates of the tilting mechanism
- slide the tilt-in-space plates of the frame until the moving value s in the picture
- tighten the countersunk screws of the tilt-in-space plates to a torque level of 13.5Nm

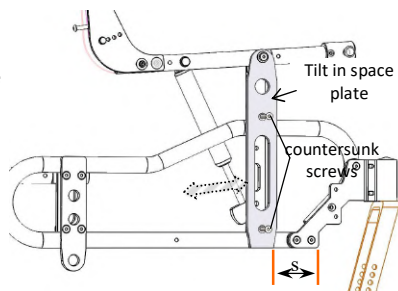

pic. 9: Displacement of the seat

Moving value s for the displacement of the seat

√ **430mm Frame height** (with 300mm and 500mm wheels) **450mm Frame height** (with 400mm wheels)

Frame size	US, XXS	XS	XS1, S	M, M1
Displacement (mm)	from 50 to 60	from 50 to 60	from 50 to 70	from 60 to 70

√ **490mm Frame height** (with 300mm and 500mm wheels) and **600mm wheels**

Frame size	US, XXS	XS	XS1, S	M, M1
Displacement (mm)	from 60 to 70	from 60 to 70	from 60 to 85	from 70 to 90

The displacement s is detected from the edge of the fork fixing plate to the first edge of the tilt-in-space plate
These values are indicative and may be changed by the professional user considering the type of combined positioning system (example: very thick backrests, very pronounced tilting and reclining).



After each operation check the position of the brakes and, if needed, perform adjustment as reported on page 7 point 6. After having performed these operations make sure that the Frame is easy to move and that all components work in harmony. If you hear noise, vibrations or if there are any changes to the normal conditions of use, please contact the Professional User; He will check the safety conditions, the suitability for use and the effectiveness of the Device.

- Displacement of the posterior wheels plate -

The displacement of the posterior wheel plates can be done as follows (pic 10):

- unscrew and loosen the countersunk screws of the wheels plates
- slide the plates along the frame to the moving value t in the picture
- tighten the 4 countersunk screws of the plates to a torque level of 13.5 Nm.

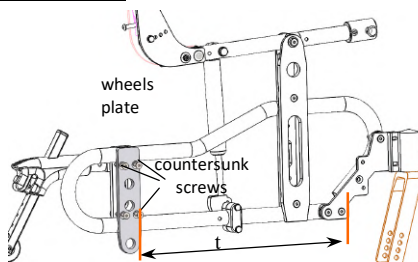

Moving value t for the displacement of the seat

pic. 10: Displacement of the posterior wheels plate

- √ **430mm Frame height** (with 300mm and 500mm wheels) **450mm Frame height** (with 400mm wheels)

Frame size	US, XXS	XS	XS1, S	M, M1
Displacement (mm)	from 360 to 390	from 370 to 390	from 380 to 400	from 380 to 410

- √ **470mm - 490mm Frame height** (with 300mm and 500mm wheels) and **600mm wheels**

Frame size	US, XXS	XS	XS1, S, L	M, M1, XL
Displacement (mm)	from 330 to 350	from 340 to 360	from 340 to 370	from 360 to 380

The displacement t is detected from the edge of the fork fixing plate to the first edge of the wheel plate.
These values are indicative and may be changed by the professional user considering the type of combined positioning system (example: very thick backrests, very pronounced tilting and reclining).



After each operation check the position of the brakes and, if needed, perform adjustment as reported on page 7 point 6. After having performed these operations make sure that the Frame is easy to move and that all components work in harmony. If you hear noise, vibrations or if there are any changes to the normal conditions of use, please contact the Professional User; He will check the safety conditions, the suitability for use and the effectiveness of the Device.

6) Multiadjustable Kit ABS Laterals with armrest (where provided)

1) Armrest

Armrest can be height and depth adjustable (pic 11.1)

◆ Height adjustment

1. unscrew the relevant threaded pin lock
2. adjust the height by moving the vertical bar up and down
3. once the desired position is achieved, tighten the pin lock in the relevant hole

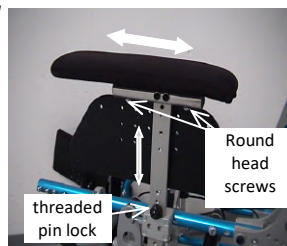

pic. 11.1: Armrest adjustment

◆ **Depth adjustment**

1. unscrew the round head screw that fix the armrest to the supporting tube
2. engage the holes under the armrest to adjust the depth (the holes are placed at a distance of 25mm).

2) **ABS Lateral**

The ABS lateral is fitted of a row of holes placed at a distance of 25mm which allow a wide range of adjustment both in depth and height.

◆ **Depth adjustment** (pic 11.2)

1. unscrew the 2 countersunk screws located in the inner part of the ABS lateral
2. adjust the position of the lateral by sliding it horizontally
3. tighten the screws when the desired position is achieved.

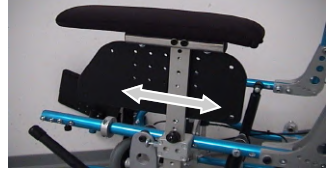

pic. 11.2: Depth adjustment

◆ **Height adjustment** (pic 11.3)

1. unscrew the 2 countersunk screws located in the inner part of the ABS lateral
2. adjust the height of the lateral by sliding it on the vertical bar
3. tighten the screws when the desired position is achieved.

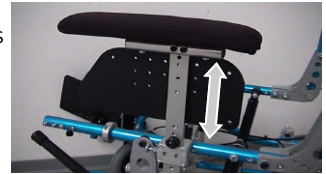

pic. 11.3 Height adjustment



Verify the correct functioning of the ABS lateral:

- 1) The correct placing of the snap pin
- 2) The not detachability of the ABS lateral

7) Flip back Tubular Armrest (where provided)

The armrest is mounted to the backrest tubes by means of mechanical clamps (pic.12) and it can be angle and height adjustable ($\pm 2.5^\circ$ with respect to the horizontal plane).

◆ **Height adjustment**

1. unscrew and loosen the countersunk screw and the hexagonal screw of the eccentric pawl
2. slide the clamp on the backrest tube until the desired height is achieved
3. re-tighten the screws

◆ **Angle adjustment**

1. unscrew and loosen the hexagonal screws locking the eccentric pawl
2. rotate the pawl of the armrest at the desired inclination
3. re-tighten the hexagonal screws

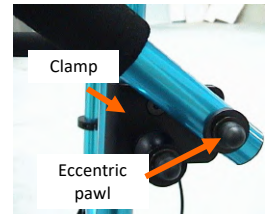

pic. 12: Tubular armrest

8) Calf Support (where provided)

The Calf Support (pic. 13) provides the posterior and lateral containment of the leg. It can be adjustable in height, by engaging the holes (placed at a distance of 25mm) drilled on the hanger, or in depth by engaging the holes drilled on the rear part of the same hanger.



Ensure Calf Supports are properly locked.



pic. 13: Calf support

9) Handles Adjustment (where provided)

Telescopic with lever block Push Handles (pic. 14.1)

- loosen the locking lever of the telescopic push handles (placed on the backrest tube) by lifting it up
 - adjust the height and direction of the handles as desired
 - close the collar locking lever
 - make sure the handles are secure and do not allow any movement.
- (The same operations can be performed in case of the single handlebar)



pic. 14.1: Lever block

Angle-adjustable single handlebar(pic. 14.2)

- press the side buttons on the handlebar
- adjust the orientation of the handlebar as desired
- release the side buttons
- make sure that the two side buttons have been released.



pic. 14.2: angle adjustable

10) Hip Guides (where provided)

The hip guides are fixed to the seat by the brackets. They present rows of threaded holes in order to allow a wide range of adjustments. The distance between the two hip guides determines the width of the seat, which is adjustable. It is also possible to adjust the depth and the height of the hip guides.

◆ **Seat width adjustment** (pic 15.1)

The width adjustment is made by changing the position of the hip guides, acting on the brackets, by means of which the hip guides are fixed to the seat base:

1. Unscrew and loosen the round head fixing screws of the bracket to the seat
2. Move the hip guide inward and outward of the seat until the desired position is achieved
3. Tighten the round head fixing screws.

For the movement of the bracket, it may be necessary that the screws engage a row of holes next to those already engaged (the rows have an interaxis of 25mm.)

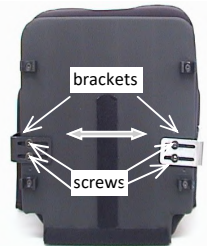

pic. 15.1: Seat width adjustment by the hip guides brackets

◆ **Depth adjustment**

It can be performed in two ways:

A) By Moving the bracket of the hip guide along the seat (pic. 15.2)

B) By Moving the hip guide along the bracket (pic. 15.3)

In A) by operating on the round head screws of the bracket, located beneath the seat:

- unscrew and remove such screws
- move the hip guide back and forth along the edge of the seat base until the desired position is achieved by engaging the relevant row of holes
- punch the cover, insert and fix the round head screws.

In B) by operating on the round head screws connecting the bracket to the hip guide:

- unscrew and loosen such screws
- slide the hip guide back and forth, until the desired position is achieved by engaging the relevant row of holes on the same hip guide
- punch the cover, insert and fix the round head screws.

For a greater movement of the hip guide, it may be necessary that the screws engage a row of holes next to those already engaged (the rows have an interaxis of 25mm.)

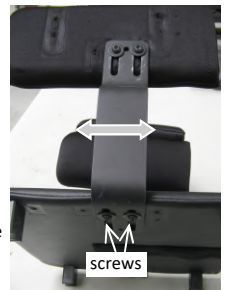

pic. 15.2: bracket adjustment

◆ **Height adjustment** (pic 15.3)

- unscrew and loosen the round head screws fixing the hip guide to the bracket
- move the hip guide up and down to the desired position
- Retighten and fix the round head screws.

For a greater movement of the hip guide, it may be necessary that the screws engage a row of holes next to those already engaged (the rows have an interaxis of 25mm.)

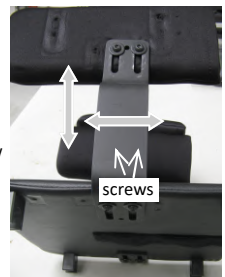

pic. 15.3: bracket adjustment

11) Arm Supports (when provided)

The arm supports are fixed to the hip guides by means of 2 slotted L brackets. They present 3 rows of threaded holes in order to allow a wide range of adjustments. They can be adjusted in height, width and depth.

◆ Height adjustment (pic 16.1)

1. unscrew and loosen the round head screws fixing the L brackets to the hip guide
2. move the arm support up and down until the desired position
3. tighten and fix the round head screws.

For a greater movement of the L bracket, it may be necessary that the screws engage a row of holes next to those already engaged (the rows have an interaxis of 25mm.)

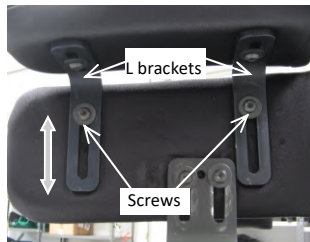

pic. 16.1: Height adjustment

◆ Width adjustment (pic 16.2)

1. unscrew and loosen the round head screws of the L bracket beneath the arm support
2. move the arm support inward and outward until the desired position
3. tighten and fix the round head screws.

◆ Depth adjustment (pic 16.2)

1. unscrew and remove the round head screws of the L brackets fixed to the arm support
2. move the arm support back and forth along the hip guide until the desired position is achieved, by engaging the row of holes under the arm support
3. punch the cover, insert and fix the round head screws.

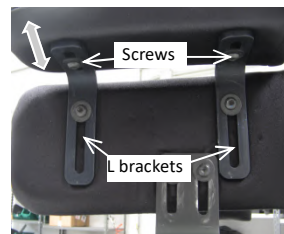

pic. 16.2: Width/depth adjustment

12) Pelvic Belt

To know more about its use, please refer to the relevant instruction manual.



Before using the system, make sure that the pelvic belt is fastened. Check the pelvic belt is fitted correctly and is suitable for the function for which it has been chosen. We do not recommend attaching the pelvic belt to the seat and wheelchair. It is not a safety belt and is not intended to be used as such.

13) Padded/Simple Calf Strap

To know more about its use, please refer to the relevant instruction manual.



Do not place the calf strap on any sensitive part.

14) Wooden Seat Base (where provided)

The wooden seat base (pic. 17) has the purpose to accommodate the positioning system and its accessories.

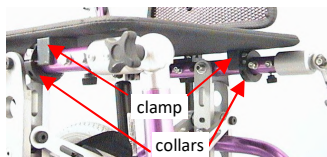

pic. 17: Wooden seat base

It can be:

- Base rivestita. Along its lateral edges it is featured of rows of threaded holes and 2

interlocking clamps both in the anterior and posterior parts that allow the mounting of the base on the frame.

So that, lay the wooden base onto the tubes by paying attention to the position of the interlocking clamps: for a good installation they should be positioned one in front and one behind the 2 collars mounted on the tubes. This operation impedes the movement of the seat backwards or forwards. The adjustments can be done by sliding the interlocking clamps along the edges of the seat base or the relevant collars along the tubes of the seat by operating through the screws. After positioning, push the seat on the tubes until you hear a locking click to indicate the 4 interlocking clamps have grafted the tubes. If there are securing clamps, you have to close them tightly on the tube after positioned.

- Raw (only wood) with mounting kit. It is featured of 1 row of holes along the lateral edges, where the provided threaded t-nuts (only wood) to be inserted. Lay the wooden base on the seat tubes and detect 2 holes both in the anterior and posterior

parts where the threaded nuts have to be inserted for the fixing of the interlocking clamps. The threaded nuts have claws that have to be completely embedded in the wood (even with hammer). The interlocking clamps have to be mounted on the face opposite to the threaded nuts. Pay attention to the 4 interlocking clamps and the 2 collars on the tubes: for a good installation the collars have to be mounted in strictly contact with the relevant clamp and be positioned alternatively one in front of the clamp in the anterior part of the base and the other behind the clamp on the opposite side in the posterior part. This operation impedes the movement of the seat backwards or forwards. After positioning, push the seat on the tubes until you hear a locking click to indicate the 4 interlocking clamps have grafted the tubes. If there are securing clamps, you have to close them tightly on the tube after positioning.



Verify the correct mounting of the seat base by checking the impossibility of movement when:
- it is moved back and forth along the seat tubes of the wheelchair
- it is pulled upward

15) Tray (where provided)

Any shape of tray can be fixed to the armrests or arm supports by detachable or lateral flip mechanism. It is secured as follows:

(option 1) Detachable mechanism (pic. 18)

- verify that the fixing L brackets firmly grip the arm supports/armrests. In a contrary case, please remove the pin and move it to a most suitable exagonal shaped hole onto the lateral edges of the tray.
- strongly tighten the locking knob
- check the tray is stable.

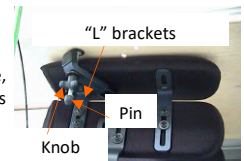

pic. 18: detachable mechanism

(option 2) Lateral Flip mechanism (pic. 19)

The mounting can be done as follows: (the pic. 19 shows the hardware only):

- mount the guide tube with its clamping knob under the arm support
- insert the rod of the hardware in the guide tube
- tighten the knob firmly
- tighten and fix the round head screws
- check the tray is stable.



pic. 19: lateral flip mechanism



Verify the correct mounting of the tray by checking it doesn't move when pulled in all directions. Verify its stability.

1.4 How to use it

The frame combined with the positioning system, after the Professional User has performed the commissioning, is ready to be used.

Daily operations such as the transfer from and to the system, must normally be performed by parents or caregiver. Following there are all modes of use. Before to start any operation the caregiver needs to be instructed by the professional user. It will require some degree of training and practice to master all operations in a safe manner. It is good to develop one's own methods for safe use, adapted to the needs.



During daily use it may happen that components and/or accessories become loose, affecting adjustments, this is why it is recommended to schedule a follow-up to monitor and check the posture. Never make any adjustments or changes without the intervention of the Professional User.

A) Use of the Frame Components

- **Backrest Tubes: installation/removal** (pic. 20)
 - Installation
 - Pull the backrest tube by the push handles and bring it in upright position
 - Insert the posterior eyelet of the gas spring into the appropriate seat of the clamp
 - Insert the quick-release pin in the relevant hole, by pressing and then releasing the button.

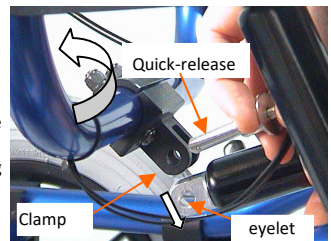

pic. 20: backrest tube installation



Check the correct positioning of the backrest tube by checking:
- the backrest tube do not move
- the quick release can't be detached.

- **Removal**

- press the appropriate button of the quick-release pin
- remove the quick-release pin from the clamp housing
- release the gas spring from the clamp housing
- lower the backrest tube.

- **Legrest Tubes: installation/removal**

- * **Swing away version** (pic. 21)

- **Installation**

Bring the legrest tube perpendicularly to the seat tube.
Insert the guide of the superior part of the tube in the appropriate receptacle.
Rotate the knee angle until the collar and receptacle pin lock.
Verify the correct positioning by checking the legrest tube does not rotate.

- **Removal**

Push the button of the receptacle; the pin rises and leaves the collar free to rotate.
Rotate the tube outward for an angle greater than 90 degrees to totally remove the collar from the pin;
Lift the tube until the guide of the superior part of the tube comes completely out from the receptacle.

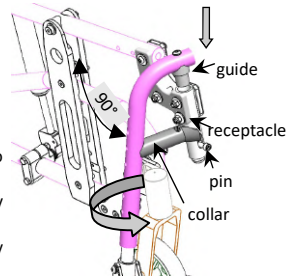

pic. 21: Knee angle installation/removal

- * **Vertical elevating and telescopic version** (pic. 22)

- **Installation**

Lay the insert of the knee angle in its housing and lock with the lever.

- **Removal**

Open up the lever and take out the knee angle.

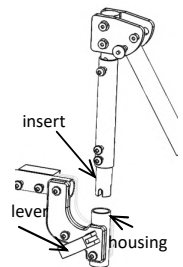

pic. 22: Vertical elevating and telescopic knee angle

- * **Detachable version**

- **Installation** (pic. 23.1)

Insert the slotted end of the legrest tube into its housing on the edge of the seat tube until a click is heard to indicate the connection.
Check that both legrest tubes are locked in position: they should not move when pulled.

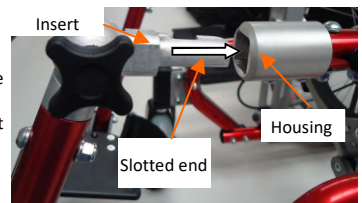

pic. 23.1: Legrest tube installation

- **Removal** (pic. 23.2)

Push the trigger outwards so that the insert is free, then pull out the legrest tube.

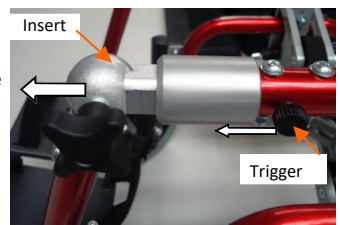

pic. 23.2: Legrest tube removal

- Anti Tip System: installation/removal

please, follow the instruction reported on page 6 point 5.

- Parking brakes

The frame is provided with two parking brakes. To activate the brake, press the lever downward until you hear a blocking noise indicating the engagement of the brake; check that the wheel doesn't move. To unlock the brake, pull the lever in its original position. The brakes are designed to be used as parking brake and do not have to be used while the frame is running. For the correct parking of the wheel, check that the distance between the brake peg and the wheel tire is equal to 6mm. In a contrary case please refer to the professional user for its adjustment. If the wheel is equipped with a drum brake there will be two lever located on the backrest tubes. Once the levers are activated, the wheels will be blocked without possibility of movement; if the levers are released the wheels will be free to move. These brakes can be used to stop the system while it is running.



When the frame is running and the drum brake has to be activated, it is necessary to operate both levers at the same time. The adjustment of the parking brake and of the activating drum brake levers must be performed by the professional user.

- Tyres

Check that the pneumatic wheels are inflated as the value reported on the side edge of the tire. Improper pressure can influence the performance of the Frame: low values can affect the manoeuvrability and action of the brake; high values can cause the tyre to burst. The replacement of the inner tube and / or tyre is like any bicycle wheel. Also check the tire profile: excessive wear can reduce the action of the parking brake.

- Pelvic Belt

To know more about its use, please refer to the relevant instruction manual.



Before using the system, make sure that the pelvic belt is fastened. Check the pelvic belt is fitted correctly and is suitable for the function for which it has been chosen. We do not recommend attaching the pelvic belt to the seat and wheelchair. It is not a safety belt and is not intended to be used as such.

- Kit ABS Lateral (pic. 24)

Installation

- Pull the spring loaded pin
- Insert the bracket in the relevant receptacle and make it slide until it stops;
- Release the spring loaded pin that blocks the bracket.

Removal

Pull the spring pin that blocks the bracket and detach the ABS laterals kit.



Verify the kit ABS lateral is blocked in a proper way by checking:

- 1) *the correct insertion of the spring pin*
- 2) *the impossibility of detachment of the Kit ABS lateral.*

- Wooden Tray (where provided)

Please follow the instruction reported on page 14 Point 15

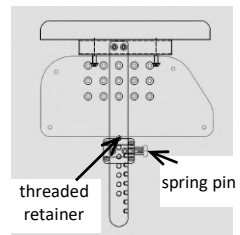

pic. 24: Kit abs lateral

B) End-user transfer from/to the System

Before performing these operations, it is important to discuss with the end user and about the most natural and regular operations that needs to be done. This will help to make it easier for the user and it will reduce possible dangers.

Transfer from the System

- √ Ensure the brakes are on, and the frame is locked from movements
- √ Ensure the anti-tip device are correctly positioned
- √ Put the seat into a horizontal position by operating the tilting lever
- √ Loosen any fixing harness
- √ Disengage any thoracic supports and hip guides
- √ Disengage the legrests by tilting the legrest tube to the side to reduce the risk of trapping feet during transfer.

Now the user is ready to be transferred. Please pay particular attention to this operation.

Transfer to the System

- √ Engage the brakes and make sure the frame is locked
- √ Ensure the anti-tip device are correctly positioned
- √ Put the seat into a horizontal position by operating the tilting lever
- √ Lift and transfer the user to the system by paying particular attention to this operation
- √ Engage any thoracic supports and hip guides
- √ Position and adjust the legrests
- √ Fasten any fixing components
- √ Make sure that the user is in his normal seating position.



While the positioning operation is ongoing, ensure that no part of the body is trapped.

C) Tilting the System

The tilting of the System is performed by activating the gas springs which are controlled by the lever located on the push handles of the backrest. Adjust the seat according to the instructions of the professional user. Tilting must be continuous and, when the lever is released, the springs will lock the seat in the position reached. The procedure is described below:

- 1) Apply the brakes and ensure the frame cannot move
- 2) Grip the push handles using both hands
- 3) Press the lever, push the handles down; tilt the frame gently and with slow movements
- 4) Release the lever when the desired angle of tilt is reached. In this way the seat will stay in such position.



During the adjustments always ensure the anti-tip system is correctly activated and that the user is well placed in the seat using the pelvic belt. Also make sure that the forearms are positioned on the relative upper limb supports in order to avoid the risk of entrapment.

D) Transporting the System

For an easy transportation of the system, it is necessary to proceed with the removal of the Positioning System from the Frame by carefully following the steps below:



Pay particular attention to the following operations; do not lift the backrest by the thoracic supports and the seat by the armrests: they can become loose and change the configuration of the System. Lift only by the components that cannot be detached. Be careful when folding the System as to not trap any moving part. Finally, upon reassembly, check that all configuration and settings have not been altered. If changes are noted, please contact the Professional User.

- Disassemble the Positioning System from the Frame and make it compact for transportation in a vehicle

In order to transport the system in a vehicle, it is necessary to remove the Positioning System from the Wheelchair Base:

- 1) Apply the brakes ensuring the frame cannot move
 - 2) Remove the seat: if there are 2 snaplock clamps, loosen and pull the seat with the wooden base upwards until it clicks, indicating that the seat clamps are detached from their relative tubes
 - 3) Remove the backrest: follow the instruction reported in the relevant Instruction Manual
 - 4) Remove the Kit ABS Lateral
 - 5) Folding down the backrest tubes; follow the instruction reported on page 14
 - 6) Remove the posterior wheels: release the parking brake by pressing the quick-release axle button and pull out the axle with the wheel
 - 7) Remove the legrest tubes: follow the instruction reported on page 15
 - 8) Disengage the anti tip system: follow the instruction reported on page 6
- Now the seat, backrest and frame can be placed in a vehicle.

- Subsequent start-up of the Frame and recombination of the Positioning System with the Frame

At the end of the trip, bring out the frame, the seat and the backrest from the vehicle and proceed with the following operations:

- 1) Assemble the posterior wheels: follow the instruction reported on page 5
- 2) Assemble the backrest tubes: follow the instruction reported on page 14
- 3) Assemble the legrest tubes: follow the instruction reported on page 15
- 4) Apply the parking brake and make sure the frame doesn't move
- 5) Fix the wooden seat base onto the frame: lay the seat base down on the tubes. Pay attention to the snaplock clamps: for a correct installation they have to get in contact with the appropriate collars on the tubes, one in front and one behind. In this way the wooden seat base will not move.

- 6) Fix the seat; please, follow the instruction reported in the relevant instruction manual
- 7) Assemble the Kit ABS Lateral
- 8) Fit the backrest: follow the instruction reported in the relevant instruction manual.



After having performed these operations make sure that the Frame combined with the Positioning System is stable, easy to move and that all components work in harmony. If you hear noise, vibrations or if there are any changes to the normal conditions of use, please contact the Professional User; He will check the safety conditions, the suitability for use and the effectiveness of the Device.

1.5 Recommendation for use

In order to guarantee safe use and a long lasting performance of the Frame for Positioning System, please find below advices for the end user:

- Carefully follow the instructions reported in this manual
- Follow the recommendations provided by the Professional User
- Keep the Device away from heat sources
- Avoid using armrests as a support base for the user
- The brake is designed for the parking and not for slowing or stopping the wheelchair while it is running.
- Carry out thorough cleaning and pay close attention to the standard maintenance.

2. GENERAL WARNINGS

All announcements reported in this section describe the conditions and situations that may cause danger to the user or to third parties. Please read carefully before using and putting the in service the System. To ensure the correct use of the Device, some operations, such as the first commissioning and adjustments, must only be performed by authorized people - the Professional User - Some daily operations can obviously be performed by the End User.

Therefore, there will be specific warnings for those concerned. In particular, the term Professional User describes the suitably qualified person (authorised dealer, orthopaedic technician, occupational therapist, healthcare professional, etc.), while, the term End User describes the person who is intended to use the Device (caregivers, family members, etc.).

2.1 Warnings for the Professional User

For further information, please contact the Technical Sales Department at the following number:

+39 0831 777840

- Max. Load: See Annex A "Technical Features"
- Preliminary Operations for correct Commissioning: (to be performed in accordance with the instructions provided in *section 1.2*)
 - * After having performed these operations make sure that the Frame combined with the Positioning System is stable, easy to move and that all components work in harmony
 - * Check for noise, vibration, or changes to the normal conditions of use to ensure safety conditions and the suitability for use.
- Adjustments: (to be performed in accordance with the instructions provided in *section 1.3*)
 - These operations must be performed by authorized people
 - During these adjustments, the anti-tip castors must be positioned to reduce the risk of the System tipping
 - After having performed these adjustments, be aware of any noise, vibrations or any changes to the normal conditions of use
 - Unauthorized modifications or the use of parts not supplied or approved by the manufacturer may affect the safe and operational integrity of the system and be cause of danger.

2.2 Warnings for the End User

Before using the Device ensure the Professional User explains the procedures for correct commissioning and standard maintenance For further information, please contact the Professional User.

- Maximum Load: See Annex A "Technical Features"

- Environmental Conditions

- a.** The Frame for Positioning System is designed for use on hard surfaces such as asphalt and paving, so:
- Do not take the wheelchair onto sand or rough terrain. This can cause damage to the wheels, axles and other components of your wheelchair
 - Use extreme caution and care if you use the wheelchair on wet and/or smooth surfaces.
- b.** Contact with water and excessive moisture can cause components of the structure to oxidise and start to show signs of decay, so:
- Do not use the wheelchair in the shower, pool or environment in contact with water. Some components may be damaged and cause malfunctions
 - Avoid extreme humid places (for example: do not bring the wheelchair into a steamy bathroom after a shower)
 - Avoid contact with seawater
 - If the wheelchair comes in contact with water or dirt, please carry out an immediate and thorough clearing
- c.** Severe environmental conditions may affect the features of the materials used, the functionality and performance of the structure, so:
- Avoid the exposure to extreme temperatures
 - Avoid prolonged exposure to sunlight. Some parts (for example the base, parking brakes, footrests and the positioning system) may overheat.

- Components and Options

Anti Tip System: This device reduces the risk of the wheelchair tipping backwards in normal conditions of use. If locked in position (downwards) the anti-tip tubes must be at a distance between 25-40mm from the floor; if they are placed too high, they do not reduce the risk of the wheelchair tipping and if too low, they can come in contact with surfaces and obstacles during normal use. Always keep the anti-tipping tubes locked in position when the end user is left alone on the base, when the system is running, make sure that the anti-tip tubes have been placed upwards.

Footrests: The footrests are the lower part of the frame and closer to the floor, so avoid to pass over obstacles that may collide with them causing damages. Also:

- Make sure user's feet do not "hang" over or become trapped between the footplates
- Do not place any weight on the footrest to prevent the wheelchair tipping forwards
- Do not stand or lean on the wheelchair footrest; they may detach from the footrest tubes or break
- Make sure, after each adjustment, that the footrest doesn't touch the front wheels.

Posterior Wheels: Every time the wheels are re-inserted please check for the correct assembly. So check:

- the quick-release axle has been activated
- the impossibility of the Wheel to be detached
- check that the pressure of the pneumatic tyres is equal to the value indicated on the tyre, as the efficiency of the brakes depends on this.

Armrest: The armrests cannot support the weight of the wheelchair. If used for lifting the chair, they may become damaged and can break.

- Use

- **Maximum Load:** See "Technical Features" reported on the Annex A
- If you hear noise, vibrations or any abnormality after a few days of use, please contact the professional user
- Be careful when moving the wheelchair over uneven ground or obstacles, which if in contact with wheels, they can cause the wheelchair to tilt.
- To reduce the risk of a tipping, do not hang bags, backpacks or any other weight on the system
- Max accepted gradient: 7°
- In the event that an accident causes a loss of performance, do not use the system and consult the professional user
- In the case of a sudden deterioration in performance, do not use the system and consult the professional user
- Never perform any adjustment or change without the intervention of the professional user
- In case of malfunctions resulting from other causes, including poor maintenance of the wheelchair, the professional user should be consulted.
- For the cleaning operations do not use aggressive products which may affect the oxidation and/or cover
- Frequently check all the connections between the positioning system and the frame and verify for a safe and fully functional operations.
- Pay attention to the hands when opening the footrest platforms.

3. NEGATIVE ADVERSE EFFECTS

Generally the use of the system should not cause any adverse effects such as allergies, skin irritations or redness (the cover is latex-free, is at low risk of irritation to the skin and it is commonly used in medical devices). Otherwise, please contact the Professional User immediately. Daily monitor the skin area which is in contact with the Device for evidence of pressure sores caused by incorrect or outdated adjustments; in this case it is suggested to suspend the use and contact the Professional User.

4. RESTRICTIONS OF USE

The Frame for Positioning System has been designed and manufactured to provide the end user the correct positioning support within the normal activities of daily working life, social relations, school or leisure time. Any other use may compromise the safety of the Device.



Mandatory Requirements

- When the wheelchair is in tilted position, the anti-tip system should always be in function
- The anti-tip system should never be removed from the wheelchair
- Do not drill or crush the gas spring
- Do not drive the wheelchair with the seat fully tilted on steep slopes
- When the system is not tilted, make sure the user is not too forward in the seat to avoid compromising the stability of the wheelchair
- When the user is on board, avoid lifting the wheelchair by the legrests or any posture accessories. If it is necessary, lift the wheelchair by the sides of the base structure, making sure the seat assembly doesn't move during this operation
- Get help from additional people when you have to lift the wheelchair over obstacles or down stairs
- All replacement parts or adjustments not authorized by the manufacturer are strictly forbidden
- For safety, never leave the user alone in the wheelchair, especially in the case of children
- If a stair lift platform is to be used, please contact the Company
- Apply the brakes whenever wheelchair-user is stationary
- Please, pay particular attention when moving on rough or uneven terrain which can damage the system
- It is recommended to never use any type of positioning harness/belt as a safety belt
- It is not recommended the use of the System for users who need shock absorbing/dynamic systems.
- Smoking and/or open flames are prohibited
- The system is not intended to be used on users with injured skin or body surfaces (sores, etc.); therefore, its use is prohibited in such circumstances.

5. STANDARD MAINTENANCE

In order to guarantee a good functioning and long lasting performances in safe conditions it is necessary to check regularly and make periodically maintenance. This operation must be performed by the end user. The regular maintenance consists of two parts: cleaning and mechanical parts checking.

- Cleaning -

The metal and plastic parts can be cleaned with a damp cloth with cold water without addition of detergent, taking care to go over everything with a dry cloth. Mechanisms such as the backrest reclining plate, tilting mechanism, parking brake and anti-tip wheels, should always be checked to remove any dust or dirt that may affect performances. We recommend these operations at least once a month.

- Mechanical Parts Checking -

The following operations have to be performed:

- Daily check the functionality of the brakes
- Weekly check the tyre pressure. Please refer to a qualified professional for inner tube replacement;
- Monthly check for tyre wear
- Monthly monitoring of parking brakes efficiency and the initial adjustments performed by the clinical professional or authorized dealer; verify that the distance between the tyre surface and the brake pin is 6mm and the operating force does not exceed 60N
- Monthly inspection the drum brake cable and adjustments
- Monthly inspection the tension of the cable for the proper operation of the gas spring
- Monthly check the screws and their tightening mechanism
- Quarterly oiling the quick-release pin of the folding back canes, the hubs and axles of the wheels, the brake pins, the screw of the footrest hangers

- Check the adjustments: it is strictly recommended to respect the program of the checks and monitoring scheduled with the professional user.

6. ADAPTATIONS WITH STRUCTURAL CHANGES AND/OR SPECIAL MAINTENANCE

Special maintenance should be performed when one or more structural components deteriorate in such way to compromise the performance and safety of users. In this case do not use the Device and immediately contact the Professional User who shall promptly inform the manufacturer about the nature of the malfunction and/or the failures found in order to proceed with the necessary interventions.

The instructions below must be followed at all times:

- Tyre wear: the tyre can be replaced by qualified professional using one with the same dimensions and features of the original. The professional user should then provide for the adjustment of the parking brakes and their efficiency
- Components failure such as wheels, forks, brakes, anti-tip castors, pushing handles and screws: they must be replaced with original parts provided by the manufacturer, restoring the original safety conditions
- Components Breakages or tears such as plates, tubes, linkage components: they must be replaced with original items provided by the manufacturer
- For all structural components it is strictly forbidden to perform any repair and repair by welding, bolted or riveted joints
- We recommend a gradual adaptation of the system to any user's needs.

The non observance of the above clauses will automatically void the CE mark.

For special maintenance, the End User must refer to the Professional User who has to send the appropriate form *Annex 1* to the manufacturer within 24 hours of the request for intervention.

7. PERFORMANCE AND DURABILITY

Pro Medicare S.r.l. ensures that its own production of Frames for Positioning Systems and/or accessories have been designed and produced in compliance with the safety regulations as required by the relevant Regulation (EU) 2017/745.

The benefits provided by the above mentioned medical devices, either individually or in combination, are therefore suitable and respond to the project's purpose, which is the mobility of users with severe disabilities, considering a more effective rehabilitation plan based on correct posture and stability.

The realistic life span of the Adacta Frame for Positioning System Range is 5 years, while the realistic life span of Versa Positioning Systems Range is approximately 3 years.

These values are purely indicative because, even if the duration expected in the design phase is much greater, it is significantly determined by the way the device is used, by the correct use and careful maintenance.

It is also reasonable to consider a slight reduction in performance over time due exclusively to:

- shocks and accidental events
- natural wear of the components.

Both performance and relative life span expectancy are however dependent by the periodic verification of the suitability, combination safety and the right System adjustments and have to be exclusively performed by the Professional User; regular reassessment by the professional user should therefore be provided in order to check the suitability, safe and integrity of the system. If the Professional User deems it necessary, he can make adjustments to provide the right support and maintenance.

The reconditioning of the device is prohibited if not expressly authorized by the manufacturer.

8. WARRANTY

Pro Medicare S.r.l. warrants the devices functionality for a maximum period of 24 months, covering all manufacturing defects from the first commissioning and 12 months on components and covers replaced under special maintenance starting from the date of commissioning after refurbishment and 12 months for wear parts.

The warranty is valid if the device is used as indicated within this instruction manual.

The warranty is voided in the following cases:

- improper use and/or in case of force majeure
- improper and/or inappropriate use for users affected by high tone and/or movement disorders
- a failure arising from an unauthorized tampering or faulty maintenance by third party that compromises the correct functionality and safety of the products
- any modification made without the manufacturer's authorization
- accidental damages and wear of the essential components
- structural changes of the end user
- failure or damages during the transportation: the Professional User is pleased to refer to the general sales conditions
- Stolen or loss.

For warranty replacement of components, the End User must refer to the Professional User who has to send the appropriate form *Annex 1* to the manufacturer within 24 hours of the request of intervention.

It is also essential for the manufacturer to receive a completed *Warranty Registration Form*.

9. POST-MARKET SURVEILLANCE AND POSSIBLE INCIDENTS

Pro Medicare S.r.l. ensures that their medical device products have been manufactured within the strict compliance, criteria and requirements established by the relevant applicable standards, guarantee functioning under the safety conditions prescribed by Regulation (EU) 2017/745. In accordance with Regulation (EU) 2017/745, Pro Medicare S.r.l. ensures and implements, pursuant to art. 83, a post-marketing surveillance system useful to monitor and ensure a clinical follow-up, in the period following the placing on the market, the degree of reliability and clinical efficacy of the medical device and in the constant search for quality improvement of the devices themselves. These activities are also ensured through an accurate market surveillance of the medical devices already on the market, as also provided by art. 84 of the same Regulation (EU)2017/745.

To ensure Post-Market Surveillance, Pro Medicare S.r.l. shall implement all activities together with Professionals and Stakeholders to establish and keep updated a systematic procedure which is useful to collect and promptly analyze the experience gained on devices that have been placed on market, in order to identify any need for improvement or modification.

The post-market surveillance system is established and implemented in accordance with the Pro Medicare's Quality Management System and is designed to actively and systematically collect, record and analyse relevant data on the quality, performance and safety of its devices throughout their lifetime, to draw the necessary conclusions and to determine, implement and monitor any preventive and corrective actions.

The post-market surveillance system also the monitoring of any incidents with the use of the device that may have caused serious physical harm to end users, caregivers or to professional users.

The result is that, in the event of any incidents, pursuant to art. 87

IT IS MANDATORY TO SEND TO THE MANUFACTURER

a copy of a fully completed *Annex 2*.

Pro Medicare S.r.l., as soon as it receives the above-mentioned form, will provide the appropriate communications to the professional and to the end user, including the possible authorisation to repair the damaged device or to replace it and according to the nature and gravity of the incident detected.

IN URGENT CASES IT IS RECOMMENDED TO CALL THE MANUFACTURER AT THE FOLLOWING NUMBER

+39 0831 777840

SENDING TO FAX THE COMPLETED *ANNEX 2* AS SOON AS POSSIBLE.

Please note that the Professional User together with Pro Medicare S.r.l. have to communicate incidents also with serious consequences, pursuant to art. 87 of the Regulation (EU)2017/745.

The Form is available for download on the Ministry of Health Website or could be provided on request by Pro Medicare.

10. DISPOSAL/RECYCLING









Please, follow the local disposal and recycling regulations.

Following there is the description of all materials used (It is recommended to proceed with a separation of the different components of the Positioning System accessories):

- **Aluminium:** headrest hardware, various type of brackets, tubes, plates, forks, footrest, backrest shell, 500mm and 600mm posterior wheels
- **Steel:** screws, threaded inserts, headrest shell, quick-releases
- **Wood:** seat bases, calf support bases, support bases, hip guide bases, trays, abductor wedge bases
- **Plastic:** internal thoracic support bases, mounting components of the base on the frame, handgrips, castors, 300mm posterior wheels, footplate, fixing elements of harnesses, seat/back structural kit, various type of padding, packaging
- Synthetic fabric covers (polyester, elastane, etc.) and padding belonging to the polyethylene or polyurethane foam family
- **Paper:** cartoon or wrapping paper.

11. LABELING

The label is placed on the lower side of the frame and it is also stuck on the second page of this manual. Product data are indicated on the label. In case of replacing parts orders and/or reports, the serial number of the product is duly requested. A facsimile of the label is shown below:

	REF _____ _____
 <p>Pro Medicare S.r.l. Via Montagna Z.I. Lotto 41 72023 Mesagne (Br) Italy tel: +39 0831 777840 fax: +39 0831 730739 e-mail: sales@promedicare.it p.i./vat n. 01803920741 MADE IN ITALY</p>	SN _____ Max. Load      



Manufacturer



Medical Device



Handle with care



Recovery/Recyclable



Consult Instruction for Use



Keep dry



CE Mark



Serial Number



Catalog Number

Annex - A "Technical Features"

This annex describes the wheelchair base, its technical and functional features. It is an integral part of the instruction manual. For further information please contact our Technical Sales Department at the following number:

+39 0831 777840

The bases of this range are made of high-strength aluminium used in the aeronautical industry, and allow significant adjustability and adaptability which ensure a seamless modularity and interchange of components to continually evolve with the users changes.

This makes it always adjustable to the user's needs by providing the possibility to periodically change the system, this is a necessary operation especially for developmental disabilities.

The Frame for Positioning System enables the continuous tilt in space between +2° and +30° for paediatric sizes and +4 and +30° for adult sizes which can be adjustable in every moment of the day by activating two gas springs operating the lever located under the push handles. By means of an aluminium plate between the seat rails and the backrest tubes it is possible to recline it in a fixed position of 3°, 9°, 15°, 22°.

Furthermore, due to a particular type of fixing plates it is possible to:

- seat depth adjustment (for a total of 80mm)
- sliding of the seat with respect to the sub-frame
- sliding of the posterior wheel plates.
- 430/490mm frame height adjustable

The Knee angle can be:

- Paediatric sizes
 - * detachable:
 - 90°, 75°
 - elevating with teathed mechanism
 - adjustable in adduction/abduction
 - vertical elevating and telescopic
- Adult sizes:
 - * detachable
 - 90°, 75°
 - elevating with teathed mechanism
 - adjustable in adduction/abduction
 - * swing away and detachable
 - 90°, 75°
 - elevating with spring mechanism (6 positions)
 - vertical elevating and telescopic with spring mechanism (6 positions)

Wheels type

- posterior wheels:
 - 300mm (poly or pneumatic or pneumatic with drum brake and lever)
 - 400mm (poly or poly with drum brake)
 - 500mm (poly or pneumatic, or pneumatic with drum brake and lever)
 - 600mm pneumatic with handrims except for US size (tilt in space reduction to 20 degrees)
- castors:
 - 150mm poly
 - 175mm poly

ADACTA LEO FRAME TECHNICAL FEATURES

	US	XXS	XS	XS1	S	M	M1
Load (kg)	50	50	50	75	75	100	100
Frame weight (kg)	15.5	15.7	16.1	19.8	20.4	21	21.7

NOTE: Frame weight with wheels, knee angle and footrest as per standard configuration

Width (mm)		US	XXS	XS	XS1	S	M	M1	
300mm wheel	standard	480	530	530	560	590	590	620	
	with drum brake	490	540	540	570	600	600	630	
400/500mm wheel	standard	500	550	550	580	610	610	640	
	with drum rake	530	580	580	610	640	640	670	
600mm wheel			550	550	580	610	610	640	
Pivot width (mm)		690	690	720	750	750	780	780	
Q*(min-max) height from the seat tube to the footrest (mm)		130-230	130-230	130-260	280-360	280-360	320-400	320-400	
H** seat rail to floor (mm)		430-490 with 300/500mm posterior wheels and 150/175mm castors 450 with 400mm posterior wheels and 150/175mm castors 470 with 600mm posterior wheels and 150mm castors							
Max slope		7°							

NOTE: * The value Q, referred to the hanger at 90° can be increased of 5-7 cm. with the use of the hanger at 75°

**The value H is taken outside to outside seat tube at the tilt in space plate.

NOTE: The length dimensions, referred to the average values, are subjected to variations due to the displacement of the plates. The values reported are intended for the standard configuration.

			US	XXS	XS	XS1	S	M	M1	
Length (mm)	300mm Wheel	Without knee angle	L	700	700	730	750	750	780	780
		75° Hanger	L _{min}	920	920	930	970	970	1000	1000
			L _{max}	990	990	1000	1040	1040	1070	1070
		90° Hanger	L _{min}	880	880	910	930	930	960	960
			L _{max}	940	960	990	1000	1000	1030	1030
		400mm Wheel	Without knee angle	L	740	740	770	790	790	820
	75° Hanger		L _{min}	950	950	960	1000	1000	1030	1030
			L _{max}	1010	1010	1030	1070	1070	1100	1100
	90° Hanger		L _{min}	930	930	940	960	960	990	990
			L _{max}	990	990	1000	1020	1020	1040	1040
	500mm Wheel		Without knee angle	L	780	780	810	840	840	870
		75° Hanger	L _{min}	980	980	990	1030	1030	1060	1060
L _{max}			1030	1030	1070	1130	1130	1160	1160	
90° Hanger		L _{min}	950	950	970	1000	1000	1030	1030	
		L _{max}	1010	1010	1020	1060	1060	1090	1090	
600mm Wheel		Without knee angle	L	/	830	840	850	850	880	880
	75° Hanger	L _{min}	/	1010	1030	1080	1080	1110	1110	
		L _{max}	/	1090	1120	1160	1160	1200	1200	
	90° Hanger	L _{min}	/	980	1010	1050	1050	1080	1080	
		L _{max}	/	1040	1070	1120	1120	1160	1160	

Weight and overall dimension of the frame (mm) with folded down backrest tubes, footrest and posterior wheels detached

Size	US	XXS	XS	XS1	S	M	M1
Lenght	660	660	680	710	730	830	830
Width	420	480	480	510	540	540	570
Height	650	650	660	670	670	680	680
Weight (Kg)	11.5	11.7	12.1	14.5	15.1	15.7	16.7

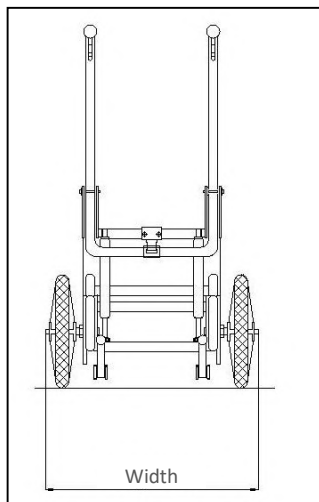
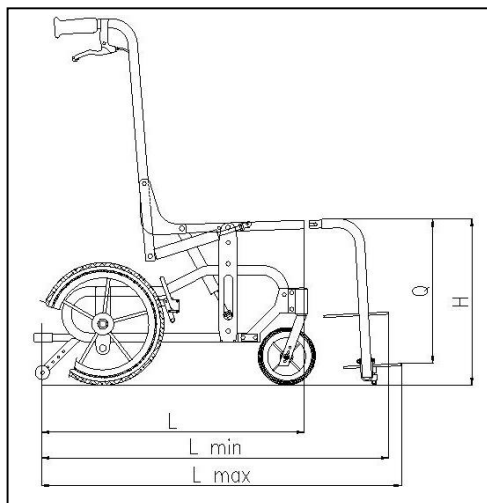

L = Length of the frame without knee angle

L_{min} = Length of the frame with knee angle and footplate positioned backward

L_{max} = Length of the frame with knee angle and footplate positioned forward

NOTE: The length dimensions, referred to the average values, are subjected to variations due to the displacement of the plates. The values reported are intended for the standard configuration.

Angle adjustments

◆ Tilting (continuous tilt in space by gas spring):

- From US to XS size: from 2° to +30°*
- From XS1 to M1 size: from 4° to +30°*

* it is performed by operating the reclining first

◆ Reclining (continuous reclining by gas spring):

- From 3° to +25°

Using 600mm wheels entails a tilt in space and reclining reduction to 20 degrees