

Accessories

Headrest **Versa** **capitis**  
HEAD SUPPORTS



MOUNTING SYSTEM



Mounting plate for Capitis Headrest with horizontal adjustments

CAPITIS CONFORT



CAPITIS ANATOMICO



CAPITIS CONFORT DIMENSIONS (expressed in centimeters)

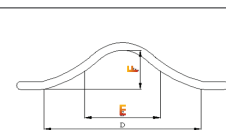
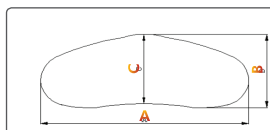

ARTICLE	A	B	C	D	E	F
PMDC01PC	21	14	13	15	08	04
PMDC01MC	30	14	13	24	10	05
PMDC01GC	42	16	14	34	14	07

CAPITIS ANATOMICO DIMENSIONS (expressed in centimeters)

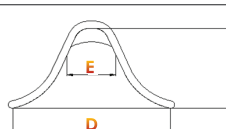
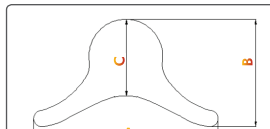

ARTICLE	A	B	C	D	E	F
PMDC02XPC	18	13	08	13	04	02
PMDC02PC	24	17	12	19	06	04
PMDC02MC	28	19	13	21	08	06
PMDC02GC	32	25	16	23	08	08

Harnesses **Versa** **fixatis**  
FASTENERS

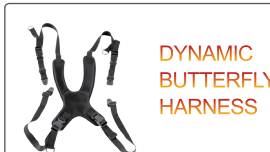

DYNAMIC BUTTERFLY HARNESS

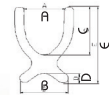

ARTICLE	A	B	C	D	E
PMD 16XS	11	18	17	05	29
PMD 16S	17	20	21	05	34
PMD 16M	20	20	26	05	46
PMD 16L	20	25	30	06	52



CHEST HARNESS WITH SHOULDERS RETRACTION PADS



ARTICLE	L	H
PMD 17S	14	16
PMD 17M	16	18
PMD 17L	23	23



TRUNK HARNESS WITH ELASTIC SHOULDER RETRACTORS AND CHEST BUCKLE CLOSURE

• H = Height of the pad  
• L = Width of the pad

ARTICLE	H	L
PMD 21XS	25	3.8
PMD 21S	35	3.8
PMD 21M	38	5
PMD 21L	45	5

Thinking **inserto**  
BACK

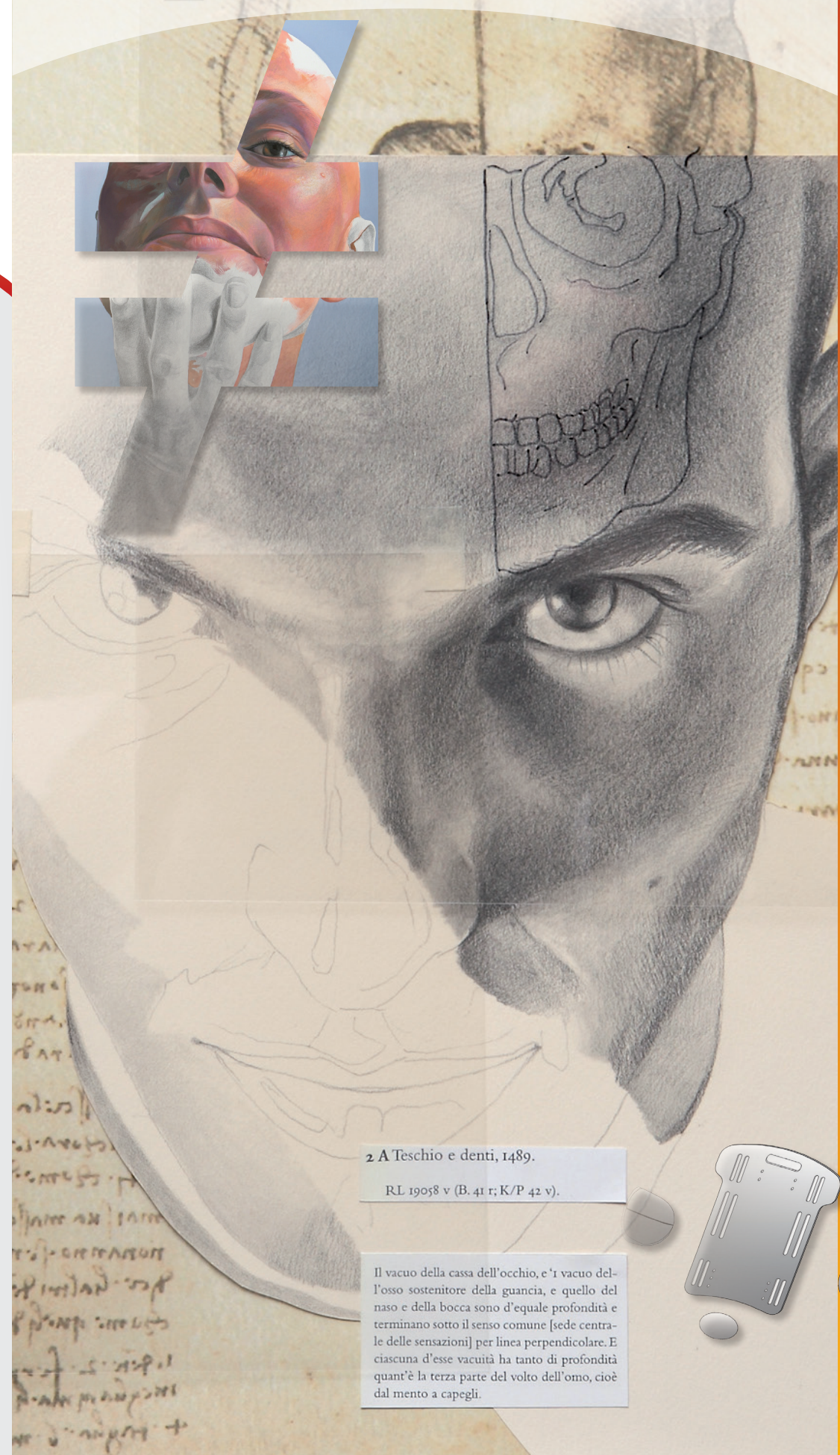

2 A Teschio e denti, 1489.

RL 19058 v (B. 41 r; K/P 42 v).

Il vacuo della cassa dell'occhio, e 'l vacuo dell'osso sostenitore della guancia, e quello del naso e della bocca sono d'eguale profondità e terminano sotto il senso comune [sede centrale delle sensazioni] per linea perpendicolare. E ciascuna d'esse vacuità ha tanto di profondità quant'è la terza parte del volto dell'omo, cioè dal mento a capegli.

BACK  
A NEW SOLUTION  
The Trunk Total Support

Versa Inserto Effecto Lato Back Catalogue EN Rev. 1 February 2014

MANUFACTURED BY:



Via Montagna Z.1 . Lotto 41  
72023 Mesagne (Br) - ITALY  
Tel . + (39) 0831. 777 840  
Fax . + (39) 0831. 730 739  
Web site: www.promedicare.it  
e mail: info@promedicare.it

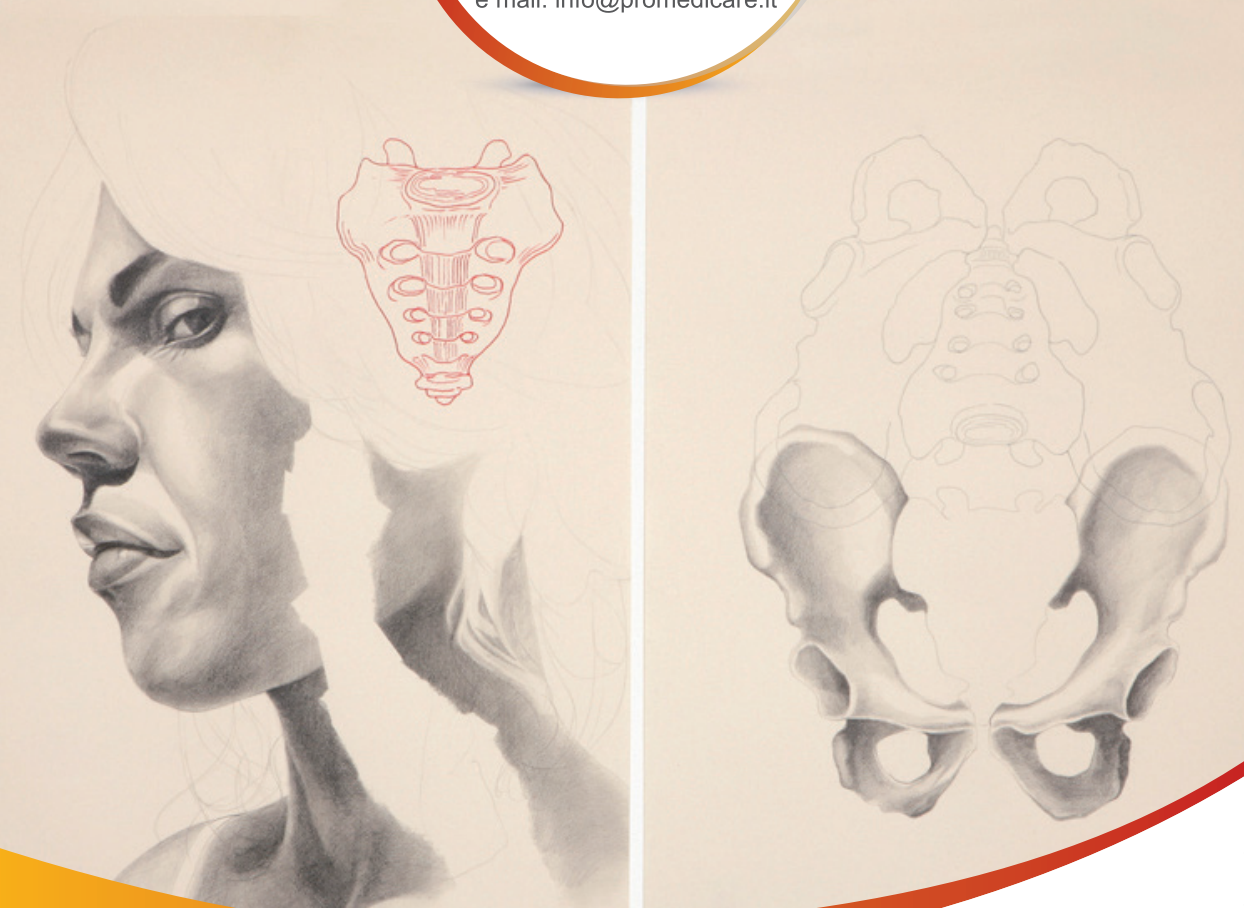

DISTRIBUTED BY:



CE 2 YEAR WARRANTY

The contents of this catalogue is the property of Pro Medicare s.r.l. - Any improper or unauthorised use is strictly forbidden  
Cover works by artist Giuseppe Ciraci - www.giuseppeciraci.com - Any reproduction is explicitly forbidden

The manufacturer reserves the right to make changes without notice.

Graphic: www.humo.it







**Why Effecto Lato** ?

ENCOURAGES TRUNK EXTENSION



Crash tested  
ISO 7176-19



3 modular  
configurable inserts

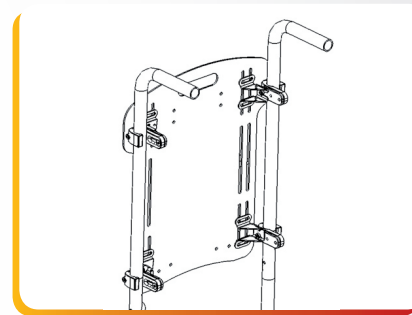

Multi-adjustable

**CLINICAL INFORMATION**

- Poor control of the trunk
- Pelvis-Trunk instability
- Severe deformities

**TECHNICAL FEATURES**

- 3 modular configurable inserts as standard
- Two layers of foam. Self-modeling polymeric foam and reticulated foam for ventilation
- Microclimatic ventilated cover
- Aluminum flat shell T shaped
- Mounting hardware kit with 4 attaching points

**SPARE PARTS**

- Cover
- Mounting hardware kit

**ACCESSORIES**

- Thoracic Supports
- Fixatis Range Harnesses
- Capitis Range Headrest
- Headrest Mounting Plate

**TTS** EMBRACING SHAPES



**inserto EFFECTO LATO**

3 modular configurable inserts

MODEL	Paediatric			Adult				
	3033	3338	3642	3945	4245	4250	4550	4855
Width (cm)	30	33	36	39	42	42	45	48
Height (cm)	33	38	42	45	45	50	50	55

• Maximum Load (referred to size 4855): 136 KG

• Compatible with wheelchair tubing diameter from 19 up to 25 mm. and from ¾" up to 1".

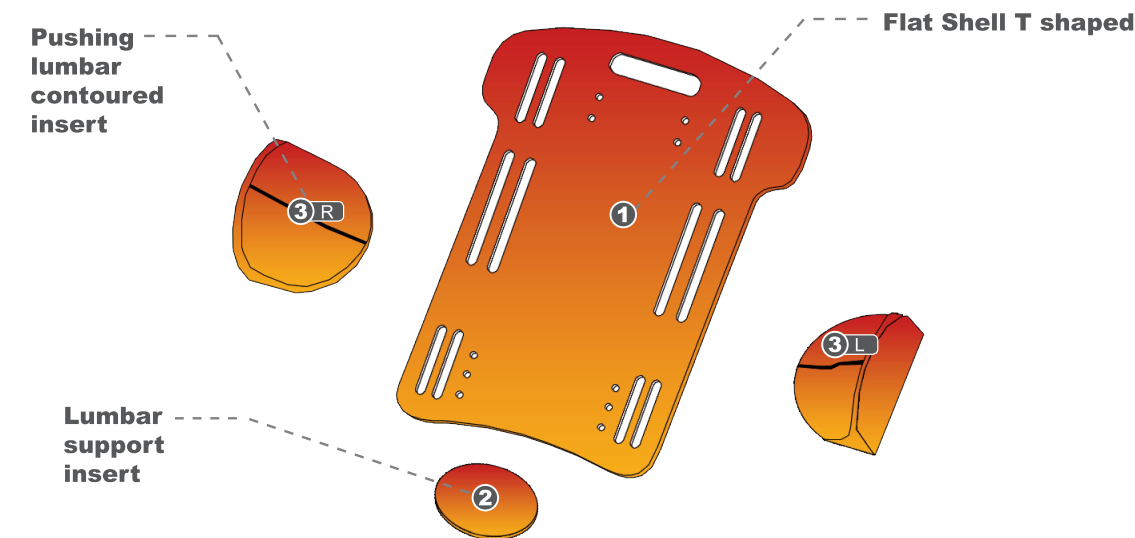

**Technical Information**

Backrest Technical Information					Patients Measures	
SIZE (cm)	Shell Height (cm)	Mounting on wheelchairs (outside tubes) (cm)	Reclination (°)	Rotation (°)	Trunk width with thoracic supports (cm)	
30x33	33	from 27 up to 33	-7 up to +7	-5 up to +5	13-23	With B type thoracic support bracket
33x38	38	from 30 up to 36			18-28	With A type thoracic support bracket
36x42	42	from 33 up to 39			16-26	With B type thoracic support bracket
39x45	45	from 36 up to 42			21-31	With A type thoracic support bracket
42x45	45	from 39 up to 45			19-29	With B type thoracic support bracket
42x50	50	from 39 up to 45			24-34	With A type thoracic support bracket
45x50	50	from 42 up to 48			22-32	With B type thoracic support bracket
48x55	55	from 45 up to 51			27-37	With A type thoracic support bracket
					25-35	With B type thoracic support bracket
					30-40	With A type thoracic support bracket
			25-35	With B type thoracic support bracket		
			30-40	With A type thoracic support bracket		
			28-38	With B type thoracic support bracket		
			33-43	With A type thoracic support bracket		
			31-41	With B type thoracic support bracket		
			36-46	With A type thoracic support bracket		

Wheelchair tubes diameter: from 19 up to 25 mm. and from ¾" up to 1"

**Thoracic Supports**

**PADS**

FLAT PAD

SIZES (cm.)	
H	6 8 10 12 12
L	8 10 12 15 18

CONTOUR PAD

SIZES (cm.)	
H	6 8 10 12
L	12 14 16 19

FLAT PAD W/ARMPIT CUT

SIZES (cm.)	
H	8 10 12 12
L	10 12 15 18

CONTOUR PAD W/ARMPIT CUT

SIZES (cm.)	
H	8 10 12
L	14 16 19

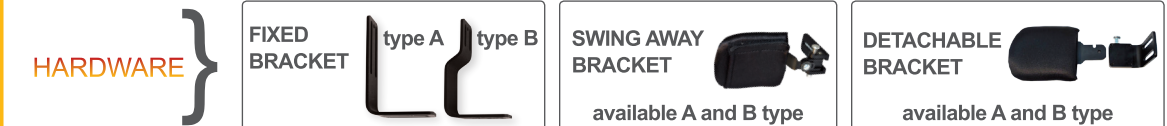

**Accessories**